

# S3

Digital variometer with speed to fly function

Version 1.09





<b>1</b>	<b>Important Notices</b>	<b>5</b>
<b>1.1</b>	<b>Limited Warranty</b>	<b>5</b>
<b>2</b>	<b>Packing Lists</b>	<b>6</b>
<b>3</b>	<b>Basics</b>	<b>7</b>
<b>3.1</b>	<b>LXNAV S3 at a Glance</b>	<b>7</b>
3.1.1	LXNAV S3 Features	7
3.1.2	Interfaces	7
3.1.3	Options	8
3.1.3.1	External Options	8
3.1.4	Technical Data	8
<b>4</b>	<b>System Description</b>	<b>9</b>
4.1.1	Push Button	9
4.1.1.1	Power Button	9
<b>4.2</b>	<b>Rotary Switch</b>	<b>9</b>
<b>4.3</b>	<b>Switching on the Unit</b>	<b>10</b>
<b>4.4</b>	<b>User Input</b>	<b>10</b>
4.4.1	Text Edit Control	11
4.4.2	“Spin” Control	11
4.4.3	Selection Control	11
4.4.4	Checkbox and Checkbox List	11
4.4.5	Slider selector	11
<b>4.5</b>	<b>Switching off</b>	<b>13</b>
<b>5</b>	<b>Operating Modes</b>	<b>14</b>
<b>5.1</b>	<b>Main screen and needle</b>	<b>14</b>
<b>5.2</b>	<b>Quick access menu</b>	<b>15</b>
<b>5.3</b>	<b>Settings Mode</b>	<b>15</b>
5.3.1	Logbook	15
5.3.2	QNH	16
5.3.2.1	QNH	16
5.3.2.2	Set elevation	16
5.3.3	Vario Parameters	16
5.3.3.1	Vario needle filter	16
5.3.3.2	Vario range	16
5.3.3.3	Integrator time	16
5.3.4	Sounds	17
5.3.4.1	Vario Audio mode	17
5.3.4.2	Audio frequencies	17
5.3.5	Units	18
5.3.6	Display	19
5.3.7	Polar and Glider	19
5.3.8	Password	20
5.3.9	About	21
<b>6</b>	<b>Variometer and Altimeter</b>	<b>22</b>
<b>6.1</b>	<b>Altimeter</b>	<b>22</b>
<b>6.2</b>	<b>Speed to fly</b>	<b>22</b>
<b>7</b>	<b>Flying with the LXNAV S3</b>	<b>24</b>
<b>7.1</b>	<b>On the Ground</b>	<b>24</b>
7.1.1	Power on Procedure	24
7.1.2	Set Elevation and QNH	24
7.1.3	Pre-flight Check	24
<b>8</b>	<b>Installation</b>	<b>26</b>

---

<b>8.1</b>	<b>Installing the LXNAV S3</b>	<b>26</b>
<b>8.2</b>	<b>Connecting LXNAV S3</b>	<b>26</b>
<b>8.3</b>	<b>Cut-out of S3</b>	<b>27</b>
<b>8.4</b>	<b>Ports and Wiring</b>	<b>27</b>
8.4.1	LXNAV S3 ports	27
8.4.2	Main port	28
8.4.2.1		28
8.4.3	External Audio port	28
<b>9</b>	<b>S3 UPS</b>	<b>29</b>
<b>9.1</b>	<b>LED indication</b>	<b>29</b>
<b>9.2</b>	<b>Connection</b>	<b>29</b>
<b>9.3</b>	<b>Calibration</b>	<b>30</b>
<b>9.4</b>	<b>Firmware update</b>	<b>30</b>
<b>10</b>	<b>Firmware Update</b>	<b>31</b>
10.1	Updating LXNAV S3 firmware using PC	31
<b>11</b>	<b>Revision History</b>	<b>33</b>

## 1 Important Notices

The LXNAV S3 system is designed for VFR use only as an aid to prudent navigation. All information is presented for reference only.

Information in this document is subject to change without notice. LXNAV reserves the right to change or improve their products and to make changes in the content of this material without obligation to notify any person or organisation of such changes or improvements.



A Yellow triangle is shown for parts of the manual which should be read carefully and are important for operating the LXNAV S3 system.



Notes with a red triangle describe procedures that are critical and may result in loss of data or any other critical situation.



A bulb icon is shown when a useful hint is provided to the reader.

### 1.1 Limited Warranty

This LXNAV S3 product is warranted to be free from defects in materials or workmanship for two years from the date of purchase. Within this period, LXNAV will, at its sole option, repair or replace any components that fail in normal use. Such repairs or replacement will be made at no charge to the customer for parts and labour, the customer shall be responsible for any transportation cost. This warranty does not cover failures due to abuse, misuse, accident, or unauthorised alterations or repairs.

THE WARRANTIES AND REMEDIES CONTAINED HEREIN ARE EXCLUSIVE AND IN LIEU OF ALL OTHER WARRANTIES EXPRESSED OR IMPLIED OR STATUTORY, INCLUDING ANY LIABILITY ARISING UNDER ANY WARRANTY OF MERCHANTABILITY OR FITNESS FOR A PARTICULAR PURPOSE, STATUTORY OR OTHERWISE. THIS WARRANTY GIVES YOU SPECIFIC LEGAL RIGHTS, WHICH MAY VARY FROM STATE TO STATE.

IN NO EVENT SHALL LXNAV BE LIABLE FOR ANY INCIDENTAL, SPECIAL, INDIRECT OR CONSEQUENTIAL DAMAGES, WHETHER RESULTING FROM THE USE, MISUSE, OR INABILITY TO USE THIS PRODUCT OR FROM DEFECTS IN THE PRODUCT. Some states do not allow the exclusion of incidental or consequential damages, so the above limitations may not apply to you. LXNAV retains the exclusive right to repair or replace the unit or software, or to offer a full refund of the purchase price, at its sole discretion. SUCH REMEDY SHALL BE YOUR SOLE AND EXCLUSIVE REMEDY FOR ANY BREACH OF WARRANTY.

To obtain warranty service, contact your local LXNAV dealer or contact LXNAV directly.

## **2 Packing Lists**

- LXNAV S3 (in Metric or Imperial units as specified)
- Main power cable for S3
- Manual (on USB stick)

## 3 Basics

### 3.1 LXNAV S3 at a Glance

LXNAV S3 is standalone digital vario meter with speed to fly function. The unit has standard dimensions to fit into a glider panel - 57 mm diameter (2¼"). The unit has integrated high precision digital pressure sensor, which are sampled more than 100 times per second. Data is indicated with needle driven with stepper motor and displayed on 320\*240 pixels, two-inch, high brightness colour display. To adjust values and settings, LXNAV S3 has one rotary knob combined with a push button.



#### 3.1.1 LXNAV S3 Features

- Extremely bright 2" (5 cm) colour display readable in all sunlight conditions with the ability to adjust the backlight .
- One rotary switch (knob) with push button function is used for input.
- Pre-loaded polar database for almost all gliders.
- Mechanical needle driven by stepper motor indicating vertical speed.
- 240x320 pixels colour screen for additional information such as average, speed to fly, altitude ...
- Many custom audio settings
- 100Hz sampling rate for very fast response.
- Internal speaker

#### 3.1.2 Interfaces

- Serial RS232 interface

- Audio port (Standard 3mm phono jack)

### **3.1.3 Options**

#### **3.1.3.1 External Options**

External speaker can be connected as option.

#### **3.1.4 Technical Data**

- Power input 6-16 V DC
- Consumption of LXNAV S3 at 12 V:
  - 95 mA - minimum brightness without audio.
  - 135 mA - maximum brightness without audio.
- 57 mm (2¼") standard aircraft cut-out for the LXNAV S3 vario unit; length 50 mm (not including connector).
- Weight 156 g
- Antireflective coated glass



## 4 System Description

### 4.1.1 Push Button

The Rotary switch also has a push button function. LXNAV S3 can detect short or long press of push button, in most cases short press confirms action, long press cancels action or exits from the menu. Short press means just a click, long press means pushing button for more than one second.

#### 4.1.1.1 Power Button

The system is powered up using push button. A long press system will turn the S3 off.

### 4.2 Rotary Switch

The one rotary switch/knob with integrated pushbutton function can control all functions on LXNAV S3. Main function is changing of the volume. The rotary switch moves up or down through the menus. Variables can also be changed using the switch. Pushing the button at the same time as rotating will step the values in larger increments.

Example 1:

Set elevation menu; normally, values are with step 1m. If you push button in and rotate at same time, the step will be 10m.

Example 2:

Entering password; Up/Down the numbers are changed. If you press and rotate, the cursor will move left or right. Short press will move cursor one step right.



Rotary switch with  
push button



Adjusting of volume works only on main flying screen.

### 4.3 Switching on the Unit

A short press of the button with turn on the S3. The first LXNAV welcome screen will appear with some system information (Device name, Version, Serial number...)

When the boot procedure is completed, setup elevation dialogue is shown.



By default setting Set Elevation page is disabled. It can be enabled in Setup QNH menu.

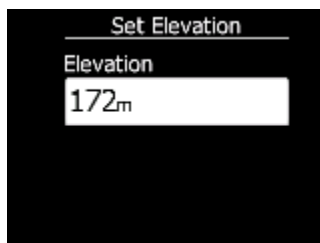

Push button also has power ON and OFF functions.

### 4.4 User Input

The LXNAV S3 user interface consists of many dialogues which have different input controls. They are designed to make input of names, parameters, etc., as easy as possible. Input controls can be summarised as:

- Text editor
- Spin controls (Selection control)
- Checkboxes
- Slider control

To move the function from one control to another, rotate the rotary knob up or down as follows:

- Clockwise rotation will select the next control.
- Counter clockwise rotation will select the previous control. PUSH button enters the selected feature.

#### 4.4.1 Text Edit Control

The Text Editor is used to input an alphanumeric string; the picture below shows typical options when editing text. Use the knob to change the value at the current cursor position.

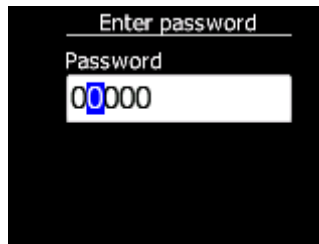

Push button will move cursor right. Holding push button and rotating knob, will move cursor left or right. At last character position, push button will confirm edited value, long press will cancel editing and exit that control.

#### 4.4.2 "Spin" Control

"Spin" controls are designed for numeric parameters. Rotate the knob to increase/decrease the selected value. Combination of push button and knob rotation will change the value with a larger step.

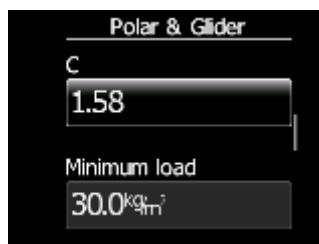

#### 4.4.3 Selection Control

Selection boxes, also known as combo boxes are used to select a value from a list of predefined values. Use the page selector to scroll through the list.

#### 4.4.4 Checkbox and Checkbox List

A checkbox enables or disables a particular parameter. Press **push button** to toggle the value. If an option is enabled a check mark will be shown, otherwise an empty rectangle will be displayed.



#### 4.4.5 Slider selector

Some values like volume and brightness are displayed as a slider

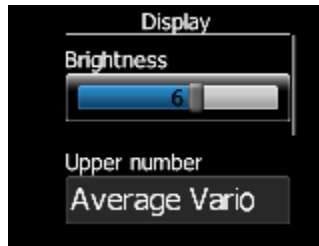

With push button you can activate slider control, then with rotation of the knob you can select the preferred value and confirm it with the push button.

## 4.5 Switching off

By pressing the push button for app. 5 seconds, LXNAV S3 will turn off.



All settings are saved in the power off procedure. We strongly recommend switching off the unit using push button and not use a separate master switch..



If the system is powered off by a master switch changed data will not be saved. Flight parameters at takeoff like target altitude and position will remain in stored memory so your final glide calculations are not affected.

## 5 Operating Modes

LXNAV S3 has three operating modes. A pilot has access to all of them using rotary knob and push button. The diagram below shows the mode structure of the LXNAV S3.

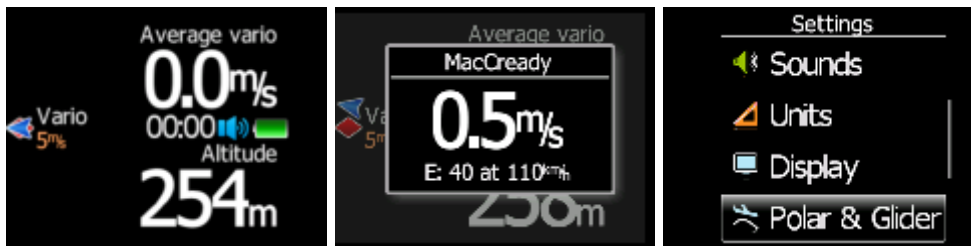

- **Main screen**, all navigation and flight parameters defined by pilot
- **Quick access**, MacCready, Ballast, Bugs.
- **Settings**, setup of the whole system

### 5.1 Main screen and needle

The main screen has a mechanical needle and a 320x240 color display with user selected data.

Description of LXNAV S3 is shown on next picture.



**Mechanical needle** displays vario. Printed scale can be chosen (when ordered) in the range of -5 to 5 or from -10 to 10. Within the software the range can be set to 2.5, 5, 10m/s or 5, 10, 20kts or 500, 1000, 2000fpm.

**Upper, middle or lower number** can be configured as average vario, altitude, altitude in feet, flight level, flight time, voltage, speed to fly, absolute pressure .

**Red diamond symbol** can show average vertical speed.

**Blue arrow symbol** shows current MacCready value.

## 5.2 Quick access menu

A short press of the push button activates the quick access menus. In the last row of the box is calculated final glide (E) and required speed for that final glide, values depends on MacCready, Bugs and Ballast setting.

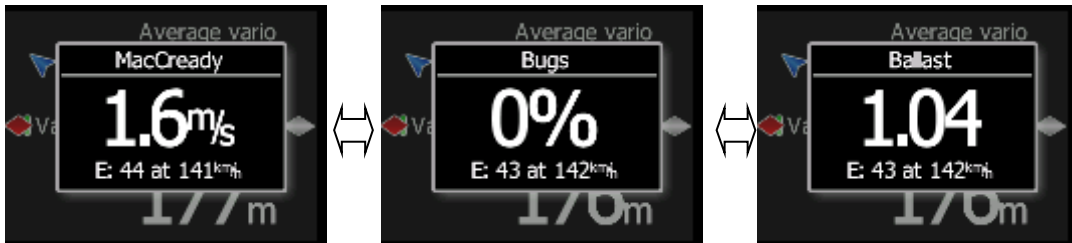

## 5.3 Settings Mode

In the setup menu users can configure the LXNAV S3. Turn the knob to select the appropriate setup item. Press the **PUSH** button to enter a menu. A dialogue or sub-menu will open.

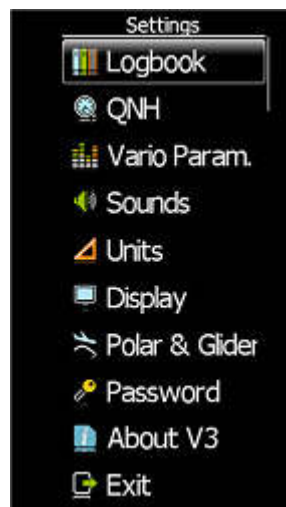

### 5.3.1 Logbook

Each flight is stored in logbook.

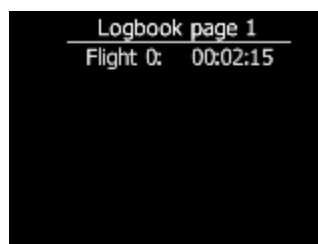

Because S3 cannot receive GPS data, only duration of the flight is written in logbook.

### 5.3.2 QNH

Turn the knob to select the required entry field. Press the **PUSH** button and start editing the value.



#### 5.3.2.1 QNH

This feature may be used to offset the altitude datum as the result of pressure changes during the flight. Since changing the QNH influences the indicated altitude.

#### 5.3.2.2 Set elevation

If Set Elevation – show on start-up, item is not checked, Set elevation menu, will not be displayed during start up. In this case, elevation will be set to standard QNE (Flight level).

### 5.3.3 Vario Parameters

This option is used to set the following parameters:

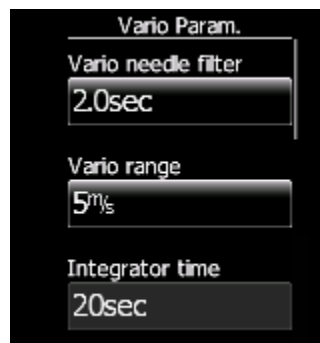

#### 5.3.3.1 Vario needle filter

Sets a time constant of the vario needle. The value can be adjusted between 0.1 and 5 s with step 1.0 s or 0.1 s. Default value is 1.5 s.

#### 5.3.3.2 Vario range

Sets full scale range of the vario (2.5 m/s, 5 m/s or 10 m/s). Default value is 5 m/s (10 kts).

#### 5.3.3.3 Integrator time

Defines the integration period for the average vario in seconds. The default is 20 seconds.



### 5.3.4 Sounds

In the Sounds setup menu audio settings for the LXNAV S3 and alarms settings can be modified.



#### 5.3.4.1 Vario Audio mode

Vario audio mode has the following options:

- **Linear positive:** sound is interrupted with silence every few milliseconds when the needle is positive; on negative side sound is linear (not interrupted).
- **Linear negative:** inverse function to **Linear positive**.
- **Linear:** sound is linear and non-interrupted in full scale range.
- **Digital positive:** similar to **Linear positive**, except frequency is not changing linearly but with larger steps.
- **Digital negative:** inverse function to **Digital positive**.
- **Linear positive only:** sound is present only at positive values, for negative values there is silence.
- **Digital positive only:** similar function to **Linear positive only**, except the sound is similar to the digital tone.

#### 5.3.4.2 Audio frequencies

- **Freq at 0%** defines the tone frequency at 0 m/s.
- **Freq at +100%** defines the tone frequency at full + deflection.
- **Freq at -100%** defines the tone frequency at full – deflection.

### 5.3.5 Units

Use this menu to specify units, UTC time offset and type of ballast input.

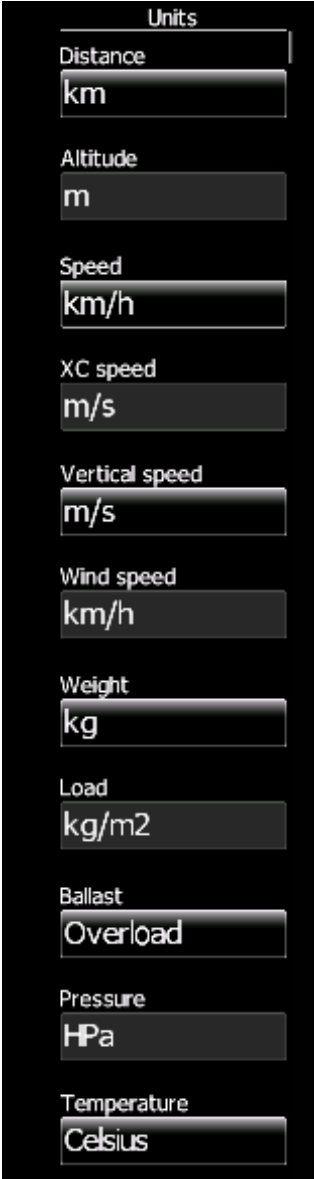

The image shows a vertical menu titled "Units" with several options, each with a corresponding unit selected in a dropdown box:

- Distance: km
- Altitude: m
- Speed: km/h
- XC speed: m/s
- Vertical speed: m/s
- Wind speed: km/h
- Weight: kg
- Load: kg/m<sup>2</sup>
- Ballast: Overload
- Pressure: hPa
- Temperature: Celsius

- **Load**, which is entered in kg/m<sup>2</sup> or lb/ft<sup>2</sup>.
- **Weight** of water ballast, which is entered in kg or lb . If this option is used the weights of the glider and pilot must be entered. Refer to Chapters 5.3.7 for more details of how to enter glider and pilot weights.
- **Ballast** can be displayed as Overload factor or Wing Load or just weight of ballast.

### 5.3.6 Display

The display menu controls screen brightness.

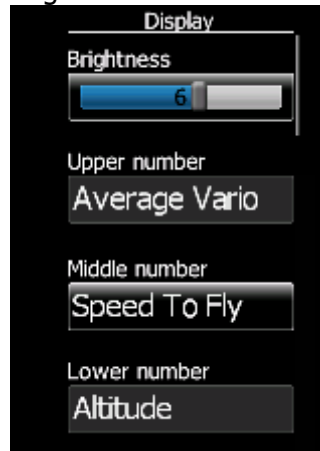

- Use **Brightness** control to adjust intensity of the LCD backlight.
- **Upper, Middle and Lower Numeric Display:** The parameter displayed can be configured. Following parameters can be displayed: average vertical speed, flight time, Altitude, Altitude in ft, Flight level, Battery voltage, absolute pressure.

### 5.3.7 Polar and Glider

Use this dialogue to enter glider polar and other glider properties. As a default polar a standard class glider is enabled automatically .



Polars for most modern gliders are already prepared. Use Glider type control, to list between preloaded glider polars.

All glider data will be copied from the chosen polar. To check the best glide ratio and minimum sink rate, to see if the polar data matches the glider performance, you may look in MacCready setting menu. You can modify the polar by changing coefficients **a**, **b** and **c**. A polar is defined as a quadratic equation with the parameters a, b, and c. Use the SeeYou program (Tools->Polar) to calculate coefficients a, b and c for a given glider's polar. The program requires three sink points entered at selected speeds (e.g.: 100 km/h, 130 km/h, and 150 km/h). The program will calculate the values of a, b and c, which should be noted and entered into the LXNAV S3.

**Stall speed** is used to generate stall warnings which are available only with integrated Voice module (Not integrated in LXNAV S3).

Weights must be entered and user should enter ballast in kilograms. There are three weights to enter. **Min. Weight** (*Minimum glider weight*) corresponds to the min.load value and represents the value at which the polar was measured or recalculated. **Max. weight** (*Maximum glider weight*) is the maximum take-off weight allowed for a glider. It is not used in the calculation, it is just a reminder to the pilot of the maximum take-off weight. **Empty weight** (*Empty glider weight*) is weight of the glider without pilot and ballast. The overload factor is calculated as:

$$\text{overload} = \frac{\text{Empty.glider.weight} + \text{Pilot.weight} + \text{Water.ballast}}{\text{Minimum.glider.weight}}$$

**Empty glider weight** is a weight of empty glider. This number can be found in a glider book.

**Pilot weight** is weight of the pilot with parachute and baggage.

**Water ballast** is a weight of ballast.

**Minimum glider weight** is a *weight of empty glider + minimum pilot weight*. This value is useful for when we want to display ballast in weight (kg or lbs).

**Maximum glider weight** is MTOW (*max. take-off weight*) – this value is used only to limit pilot to enter higher ballast, as is allowed with MTOW.

### 5.3.8 Password

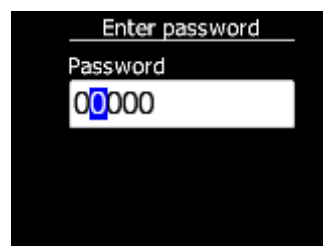

There are several passwords which run specific procedures as listed below:

- **00666** Resets all settings to factory default
- **99999** will clean logbook
- **01048** can adjust needle to zero



Do not adjust needle when airborne.

### 5.3.9 About

In about page is information about firmware versions, hardware versions and serial numbers.



## 6 Variometer and Altimeter

All signals from the pneumatic sensor (altitude) is derived from high quality pressure sensor which mean that no flask is necessary. The vario signal is derived from the altitude signal. Altitude sensor has temperature compensation. Mechanical needle and colour display show the vario information as well as many other parameters.

The display is user configurable. The variometer can be configured to show:

- **Range** 5, 10 and 2.5 m/s or 10, 20 and 5 kts.
- **time constants** 0.1 s to 5 s, in addition there are 4 settings for electronic processing for the vario signal.

Vario indications can be corrected for total energy with a TE probe. The quality of the TE compensation depends entirely on the location, size and dimension of the TE tube. The installation must be leak-proof.



Compensation with TE probe

TE is measuring a total energy (static pressure - dynamic pressure). During flight there is a speed involved, which makes the offset in the altimeter reading, which means during flight the altitude is not accurate. By increasing the speed there is even a higher altitude difference between the LX80/90xx compared to S3 vario. On the LX80/90xx this is compensated with dynamic pressure (air speed) as the vario supplied with LX80/90xx includes a speed sensor.



On the ground the altitude reading between S3 and LX80/90xx device is nearly the same, as there is no air speed present.

User has to decide which option he prefers more

- **compensated vario (s3):** connect S3 to TE probe
- **non compensated vario, but proper altitude reading:** connect S3 to static pressure

### 6.1 Altimeter

The altimeter of the LXNAV S3 is temperature compensated from -20°C up to + 60°C. The altimeter is calibrated up to 20000 m.

### 6.2 Speed to fly

Speed to fly is based on the MacCready theory is a very useful tool to optimise cross-country speed. The pilot must follow Speed to fly value on pneumatic airspeed indicator. Speed to

fly is calculated from polar of glider, actual sink rate (vario), MacCready setting, Ballast and Bug setting.

## 7 Flying with the LXNAV S3

To get the best out of the LXNAV S3 it is important that some preparation is done prior to take-off. Trying to configure the instrument or set a task while flying is very hazardous especially in a competition. At the least, it could spoil your whole day! Pre-flight preparation will ensure that the flight will be both safe and enjoyable.

### 7.1 On the Ground

#### 7.1.1 Power on Procedure

Press the push button. LXNAV S3 welcome screen will appear. The first screen shows the version of the boot loader, firmware, hardware and serial number. The boot procedure normally takes few seconds. When completed, Set Elevation dialogue is shown.

#### 7.1.2 Set Elevation and QNH

This setting is crucial for final glide calculation: therefore pay careful attention to it.



LXNAV S3 can't calculate final glide.

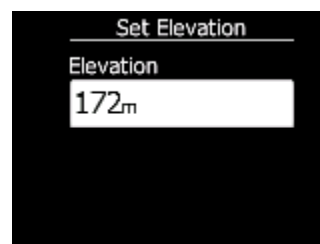

The instrument will offer elevation over standard pressure level QNE. Use the knob to fine-tune the elevation.

#### 7.1.3 Pre-flight Check

After elevation setup the LXNAV S3 will switch to normal operation mode.

It is recommended that the MacCready, ballast and bugs settings be set to match the current glider configuration. Press the **push** button. The dialogue for MacCready, Ballast and Bugs will appear.

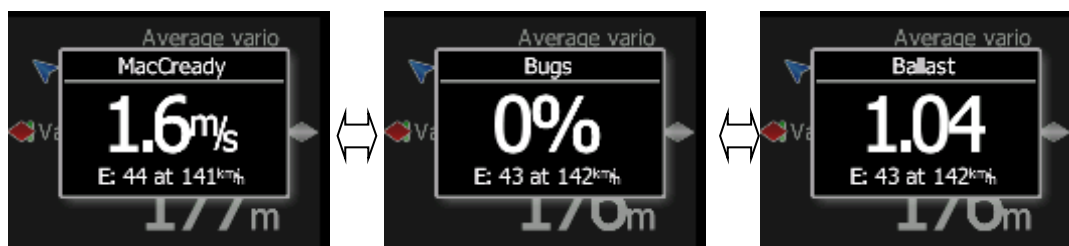



Use the rotary knob to modify the MacCready setting.

## 8 Installation

The LXNAV S3 requires a standard 57 mm cut-out.

One pressure connector is fitted to the back of the S3 vario. It's total energy (TE) pressure connector

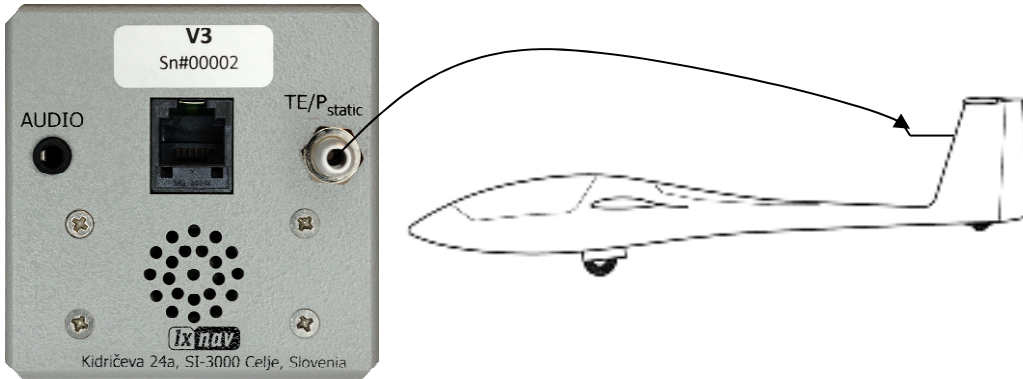

### 8.1 Installing the LXNAV S3

The LXNAV S3 vario should be mounted in a standard 57 mm hole.

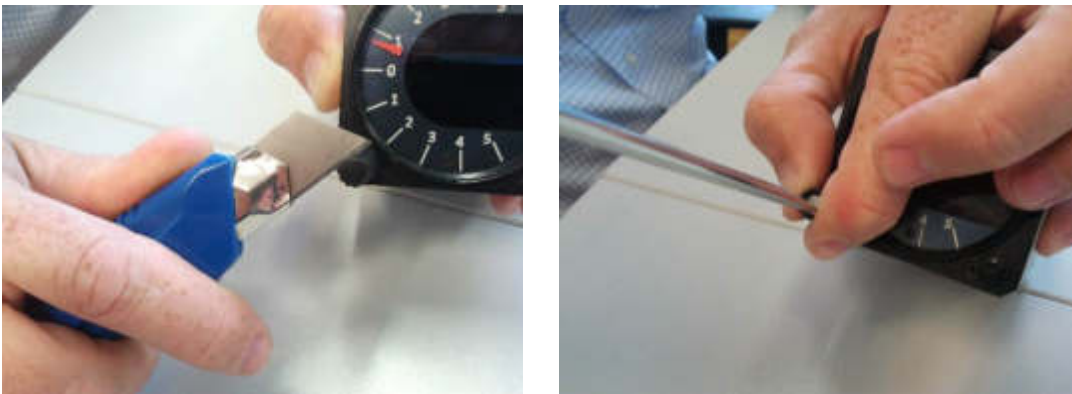

Remove rotary knob cap with a knife or flat screw driver, then hold knob and unscrew it. Remove remaining three screws. Install S3 into the panel, screw back all screws and knob. Make sure that between knob and panel is some space, to push button.



Be sure that LXNAV S3 is placed far enough from compass. Inside is stepper motor and speaker which generates magnetic field interferences.

### 8.2 Connecting LXNAV S3

LXNAV S3 is connected to 12V DC power supply. Red wire goes to + positive and blue wire goes to – ground.



Instrument has no internal fuse. **3A external fuse is required!** Power supply cables should use a minimum of 0.5 mm<sup>2</sup> wires.

### 8.3 Cut-out of S3

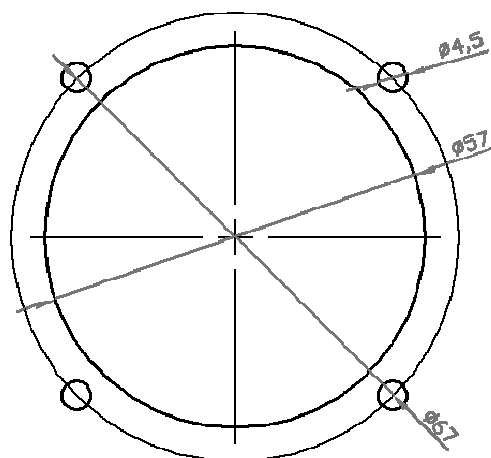

### 8.4 Ports and Wiring

#### 8.4.1 LXNAV S3 ports

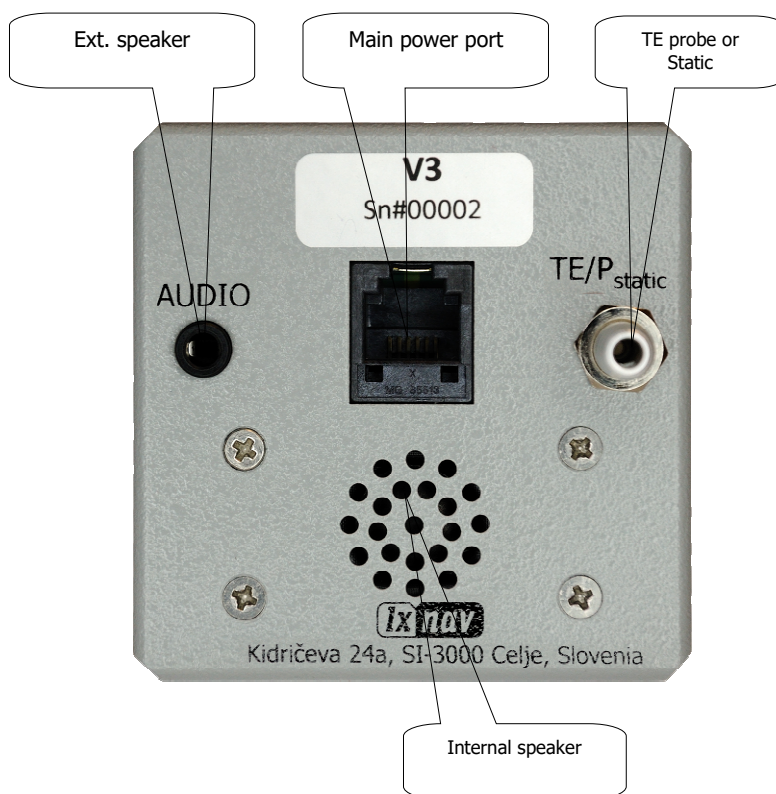

## 8.4.2 Main port

On main port is connected S3 wiring.

### 8.4.2.1



Pin number	Description
1	12V power supply
2,3	N.C.
4	(input) Receive to LXNAV S3 RS232
5	(output) Transmit from LXNAV S3 RS232
6	Ground



In the moment, serial interface is used only for firmware update.

## 8.4.3 External Audio port

Here is connected optional external speaker with standard 3mm mono phono jack.



LXNAV S3 has built in internal speaker.

## 9 S3 UPS

S3 UPS is specially designed module for S3 vario. It will power on, when S3 is turned on and shut down, when S3 is shut down. S3 UPS is charging only, when it is powered on. Charging current is max. 0.5A. It is recommended to us 1.5A fuse to supply S3 UPS.

### 9.1 LED indication

Description			
Battery full			
Battery > 66% – no charge			
Battery > 33% – no charge			
Battery < 33% – no charge			
Battery < 5% – no charge			
Battery full			
Temperature high			
Charging >66%			
Charging >33% and <66%			
Charging <33%			

- flashing LED
- solid LED

### 9.2 Connection

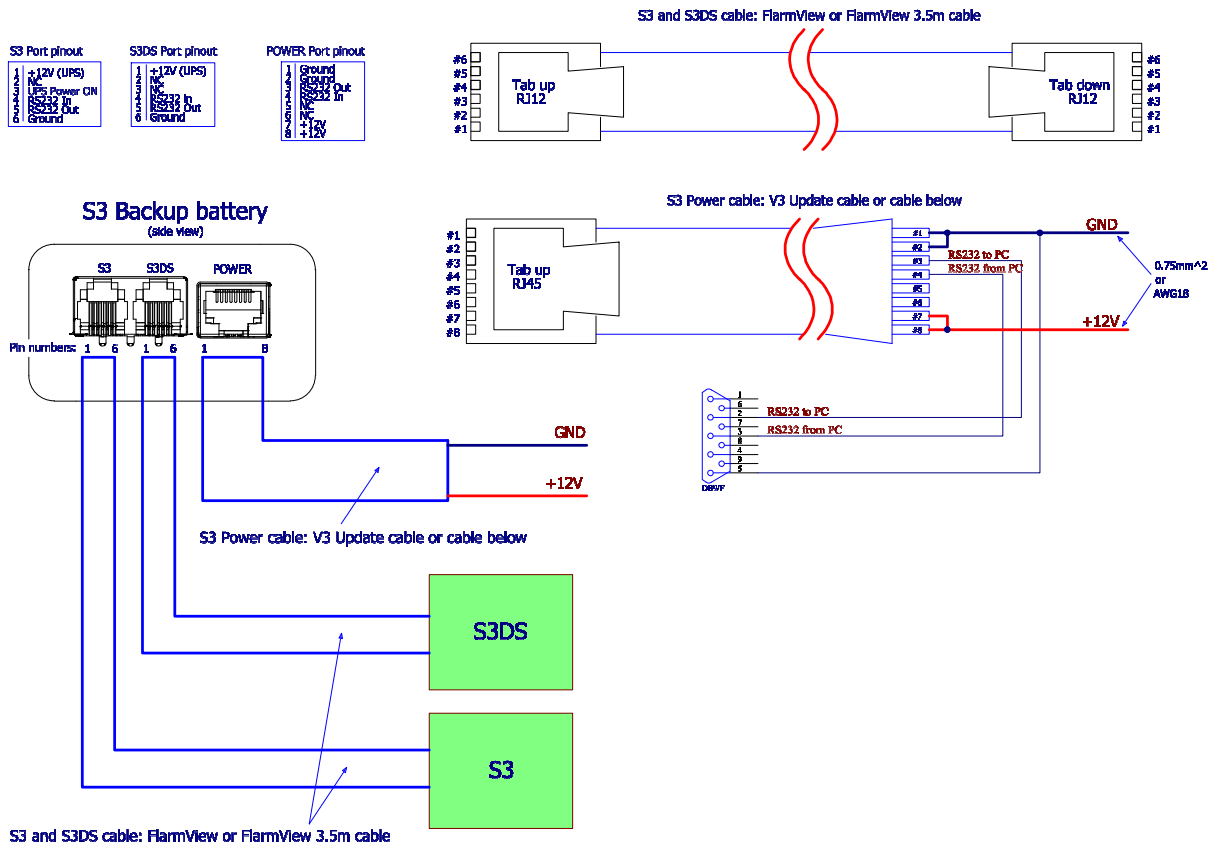



S3 vario needs hardware modification to work properly with S3 UPS. S3 delivered with UPS already have such modification.



Please contact [info@lxnav.com](mailto:info@lxnav.com), to ensure S3 vario is compatible with UPS. Non modified S3 vario connected to UPS will not shut down the UPS and will completely drain the batteries.

### 9.3 Calibration

If state of charge of the UPS is incorrect, user can do battery calibration. The calibration is simple. Leave S3 On and UPS on power supply. On battery info, observe battery calibration status. When the status changes to DIP, you can remove power supply of S3UPS and leave S3 running to drain the S3UPS battery. This cycle will measure new capacity.

### 9.4 Firmware update

Firmware update procedure of the S3 UPS is same as firmware update of the S3 Unit. Please use S3update cable, plug it into Power port of the S3 UPS, then follow procedure described in chapter 10.1. Please use firmware for S3 ups **App\_SUPS\_x.yy.lxfw**. You must apply power after pressing **Flash** button on the flashloader application.

## 10 Firmware Update

Firmware updates of the LXNAV S3 can be easily carried out using PC. Please visit our webpage [www.lxnav.com](http://www.lxnav.com) and check for the updates.

You can also subscribe to a newsletter to receive news about the LXNAV S3 automatically.

### 10.1 Updating LXNAV S3 firmware using PC

For update we need S3 cable with serial RS232 interface and free serial port on your PC. If your PC has no serial ports, you can use USB to SERIAL converter.

1. Download the latest firmware and update tool from our web site, section downloads/firmware <http://www.lxnav.com/download/firmware.html>. Firmware is compressed in a zip file. **App\_VTRI\_x.yy.lxfw**.
2. Unpack file to one folder and run FlashLoader485App.exe (PC update tool)
3. Choose firmware file **App\_VTRI\_x.yy.lxfw**



4. Choose correct **serial port** and baud rate (**115200bps**)
5. Press "**Flash**" Button.
6. Turn ON S3
7. If update starts, you will see a progress on PC and on S3.



If update procedure is interrupted of any case. LXNAV S3 will not start. It will cycle in bootloader application with red message "Flash integrity failed". Bootloader application is waiting to receive new firmware from PC. After

successful firmware update LXNAV S3 will start again.



Update cable is not included with S3.



## 11 Revision History

November 2012	Initial release of owner manual
November 2012	Corrected Ch.5.3.3.4, removed Ch.5.3.5
September 2014	Corrected Ch.4.2
September 2016	Corrected Ch6, Ch9.2
January 2020	Updated and added Chapters. 9, 9.1, 9.2, 9.3, 9.4